

TS 2000 NV
TS 2000 NV BC

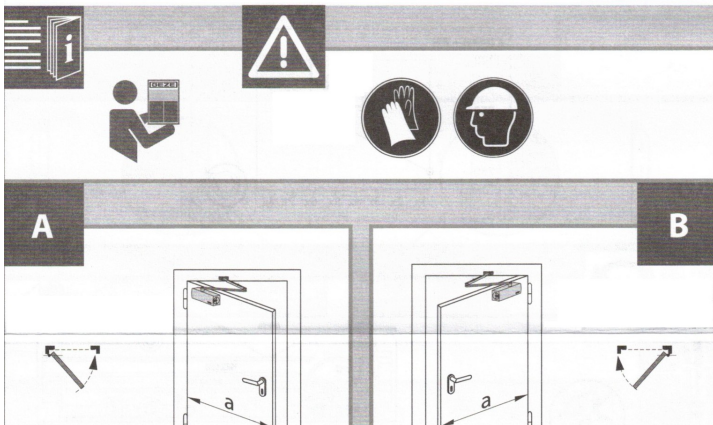



124953-04

GEZE

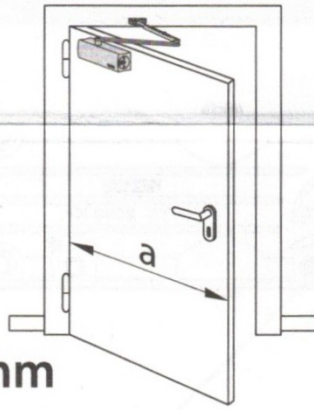
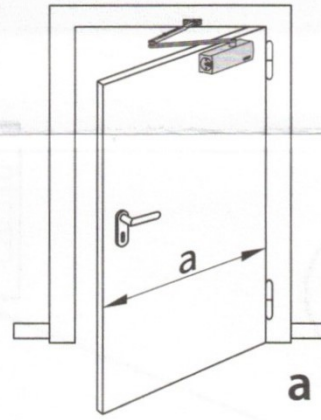
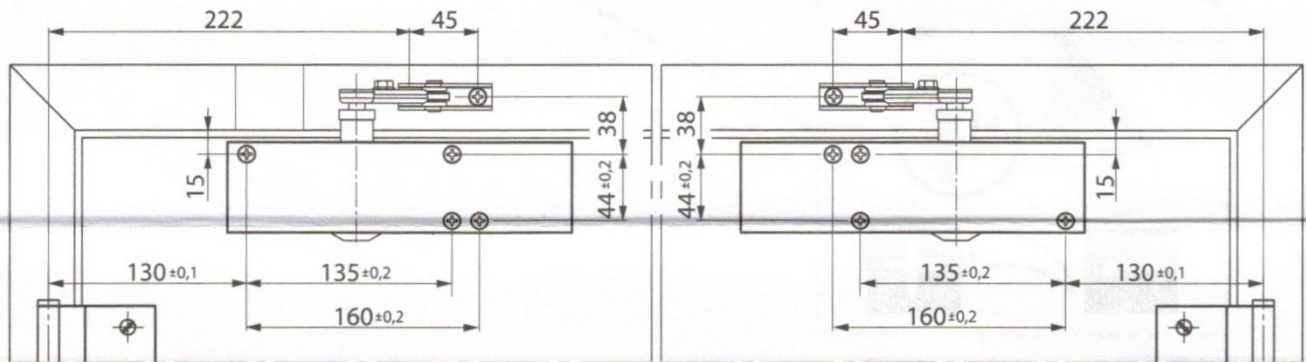
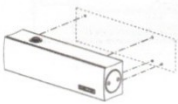
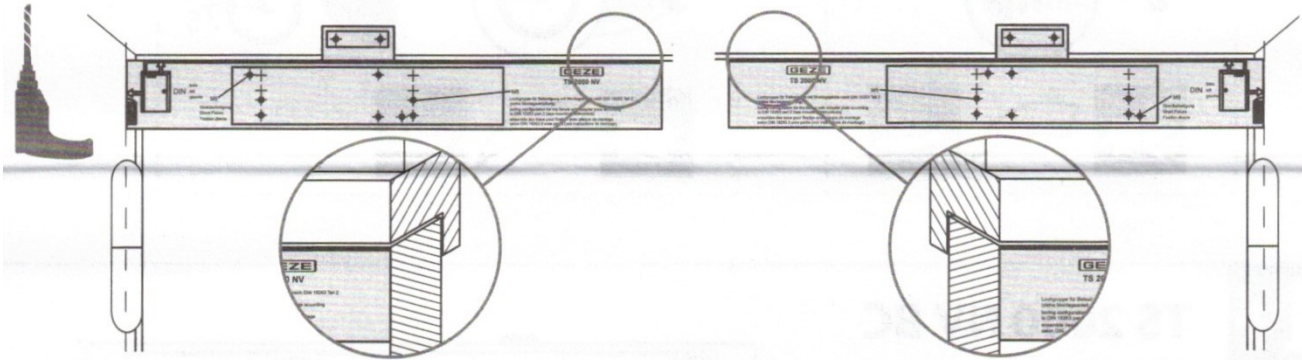
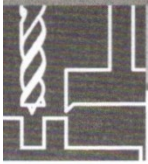

A $a \leq 1100 \text{ mm}$ **B** $a \leq 1100 \text{ mm}$ 

-  4x
-  5x70
-  4x
-  M5x55

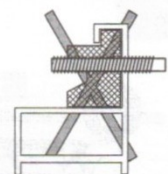
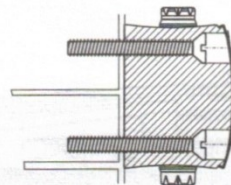
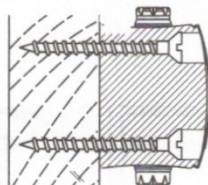

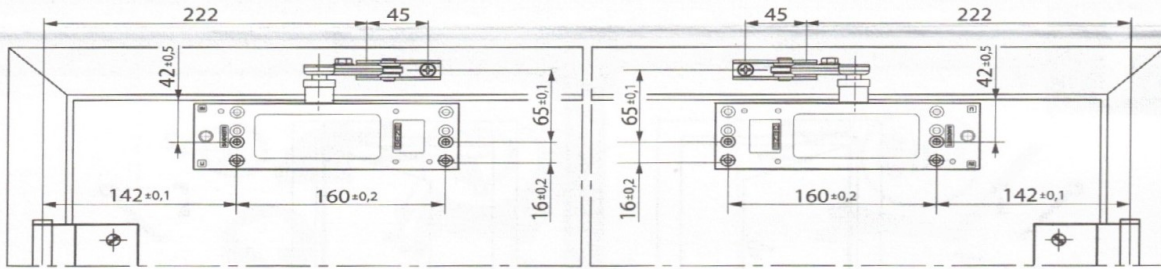
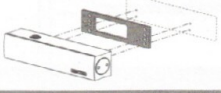

4x
5x35
4x
M5x20

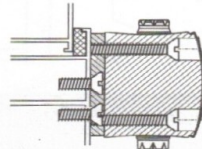
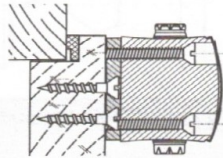

4x
M5x45

1



2

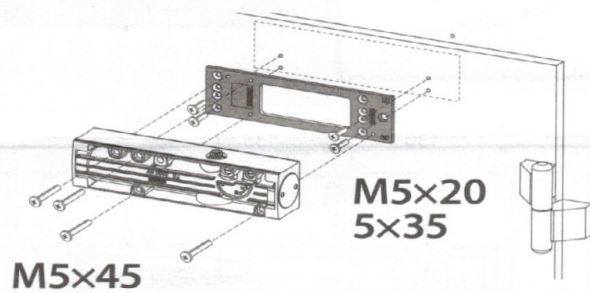
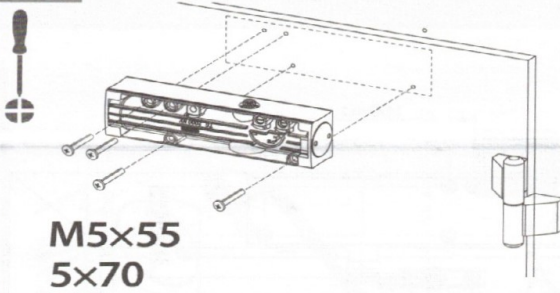

3

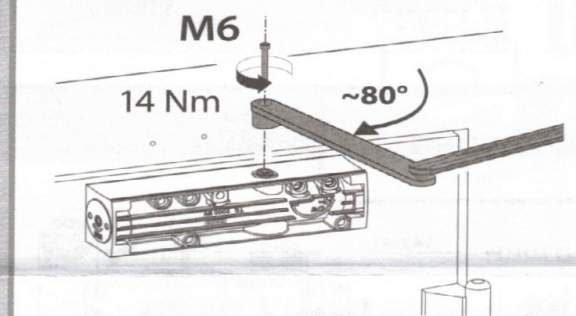
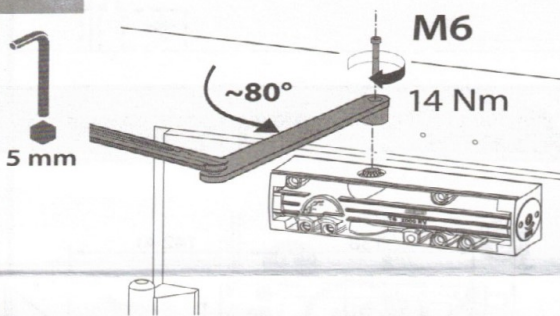

4

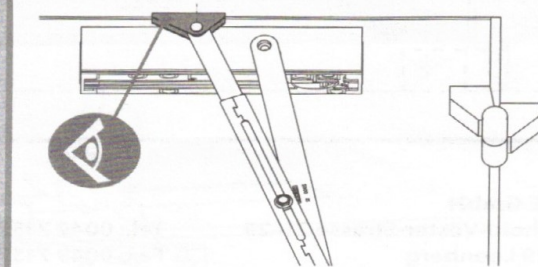
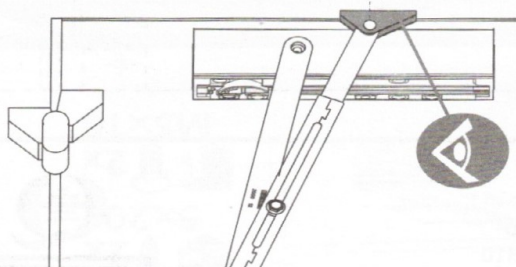

5

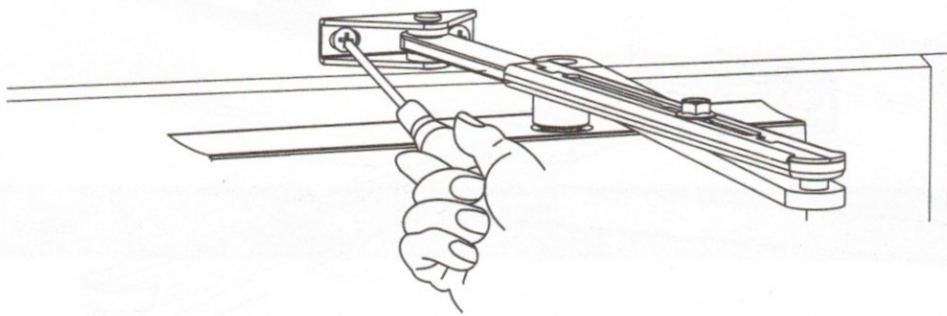

2x
5x20

2x
M5x16

6



10 mm

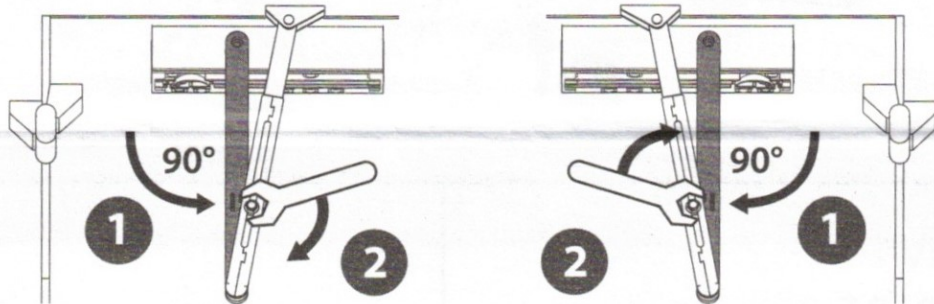

7



5 mm

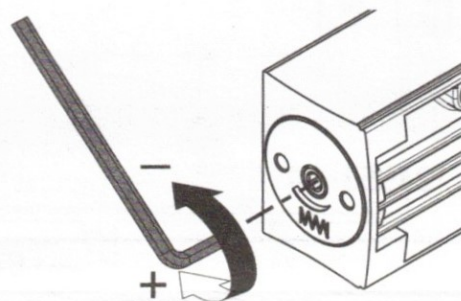
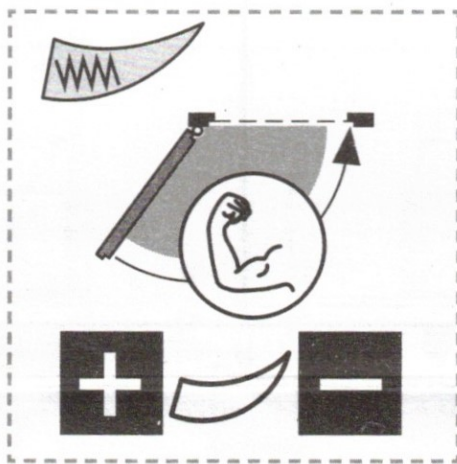
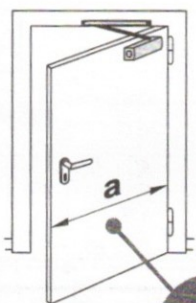

a (mm) - EN

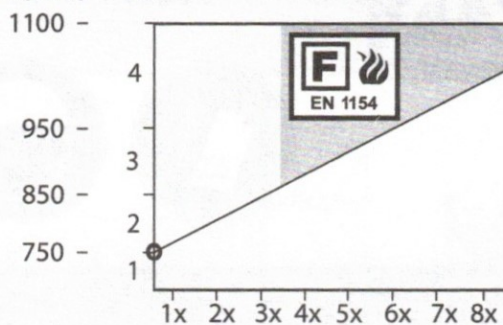

8

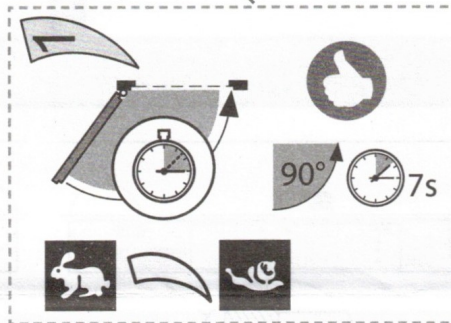
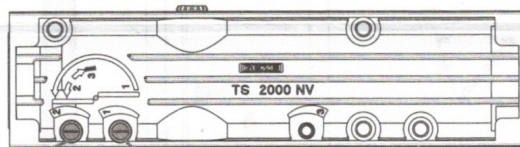

i+

TS 2000 NV BC

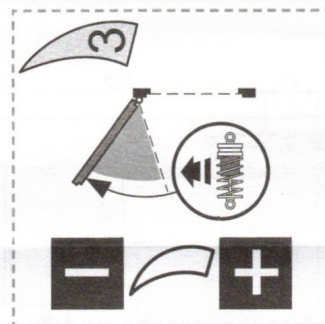
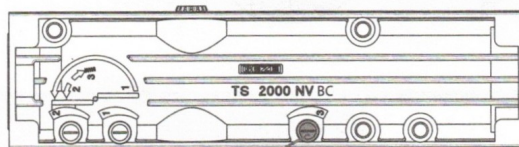

9

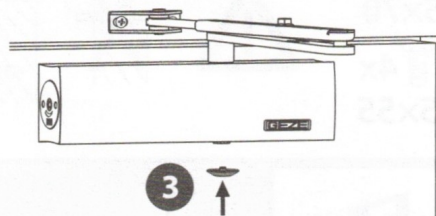
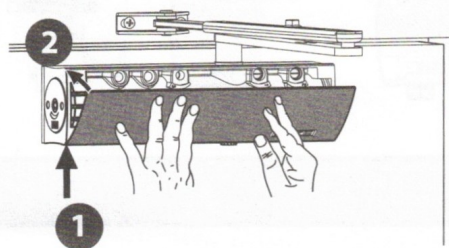

i

