

A

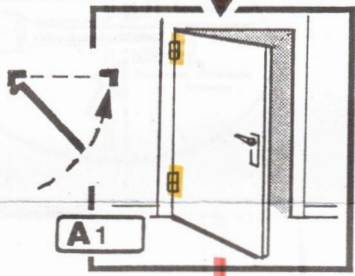

A1

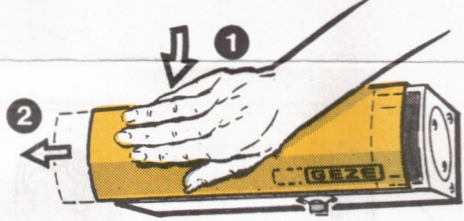
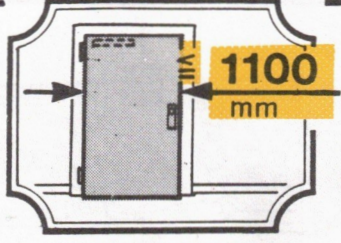

B

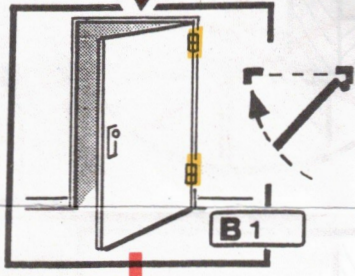

B1

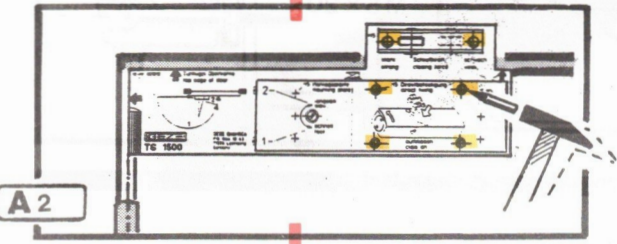

A2

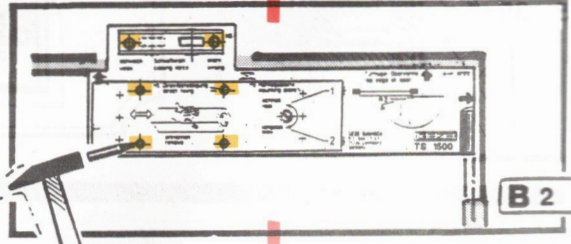
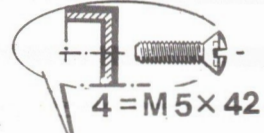

B2

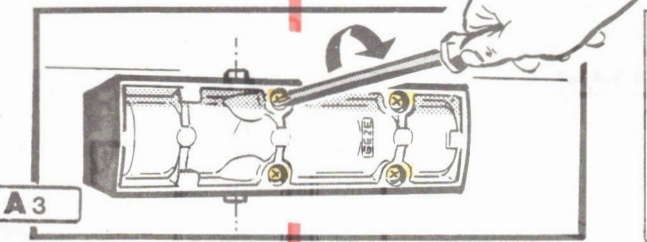

A3

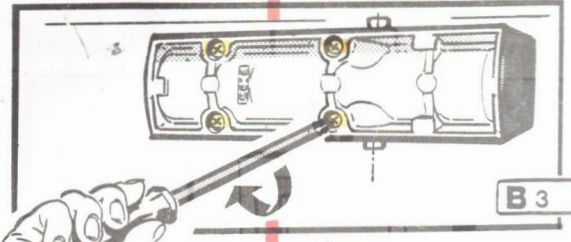
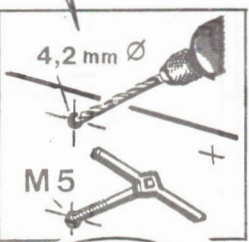

B3

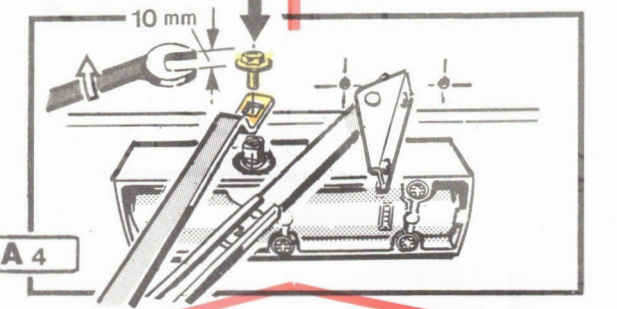

A4

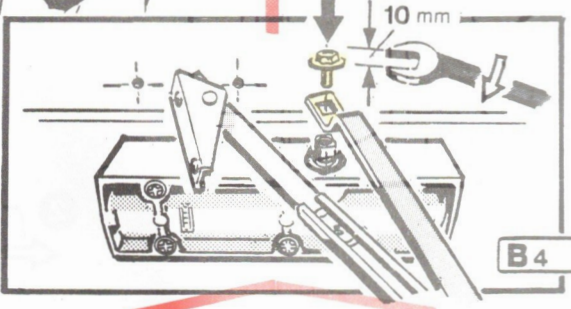

B4

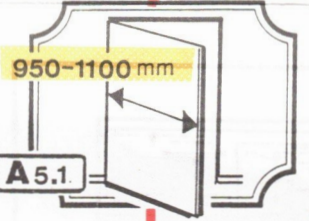

A5.1

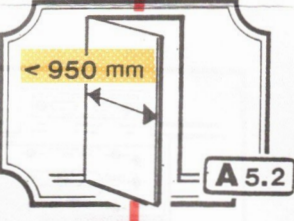

A5.2

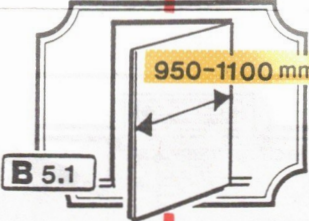

B5.1

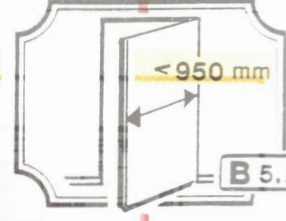

B5.2

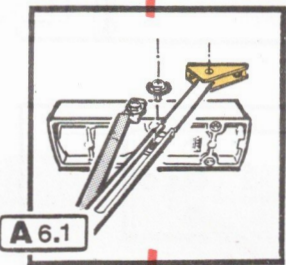

A6.1

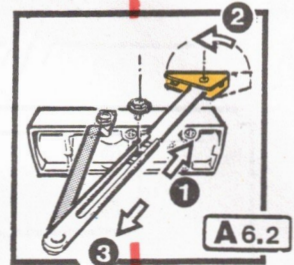

A6.2

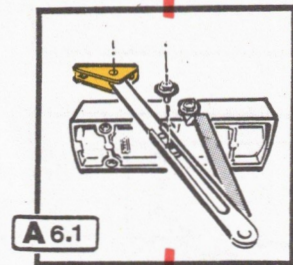

B6.1

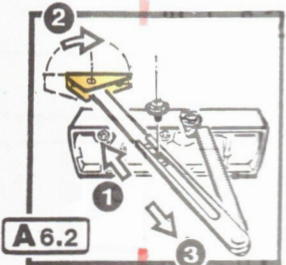

B6.2

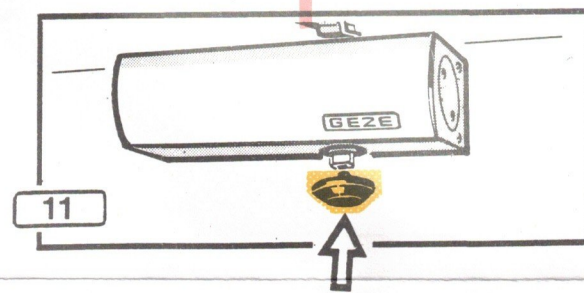
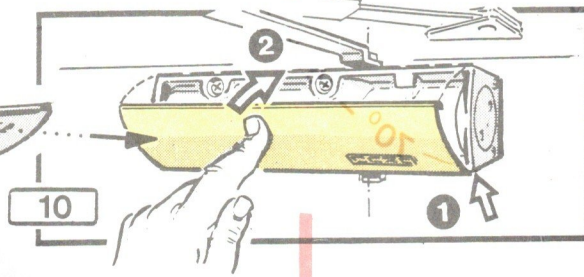
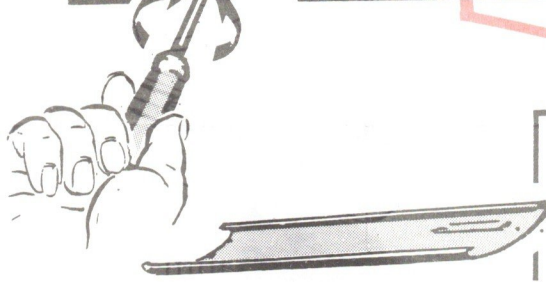
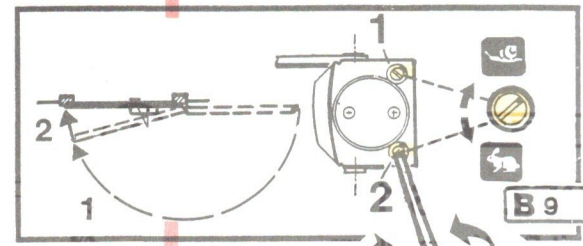
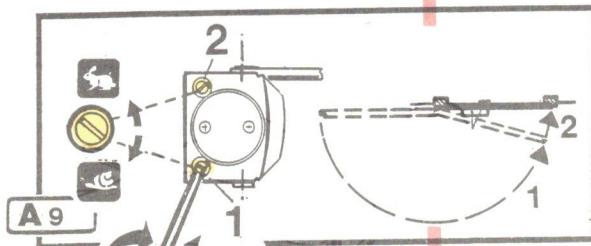
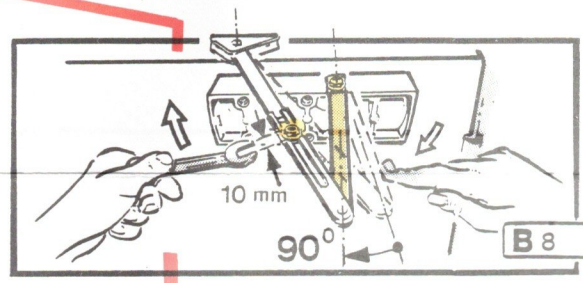
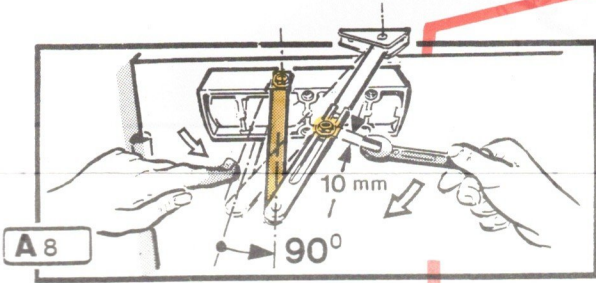
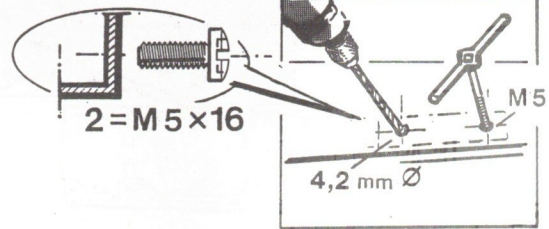
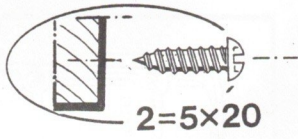

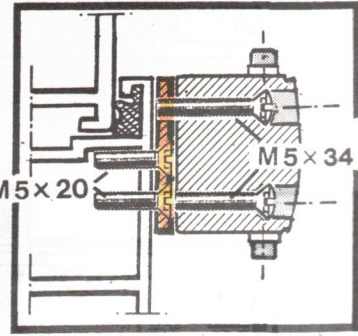
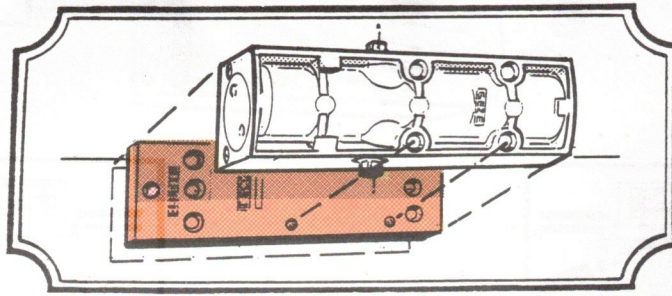
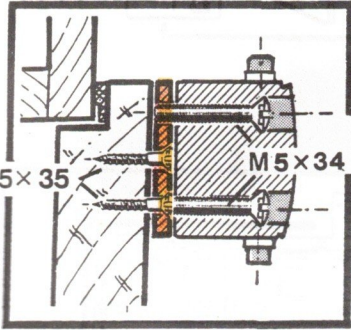
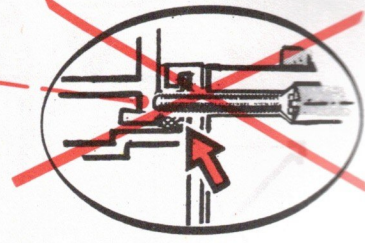
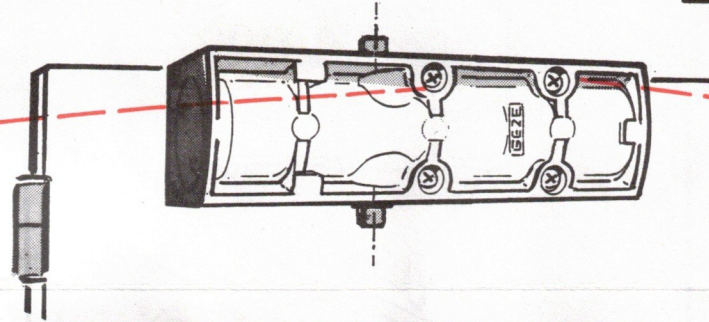
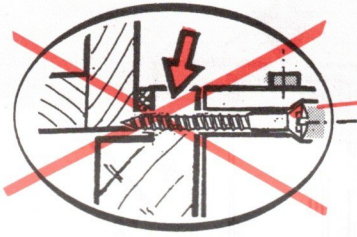

C

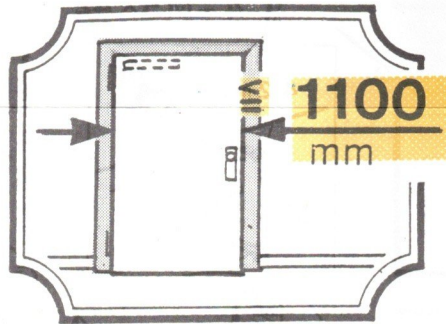
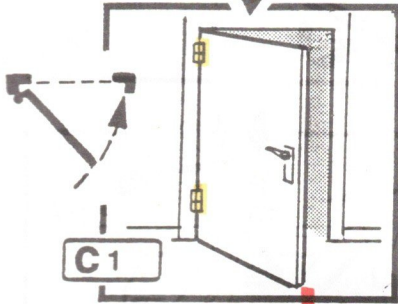

D

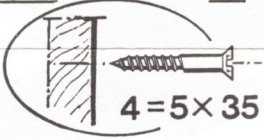
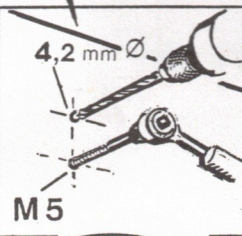
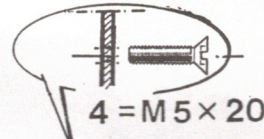
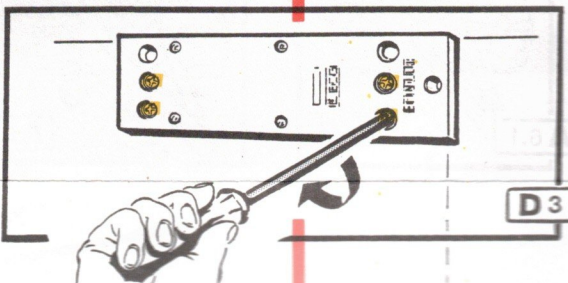
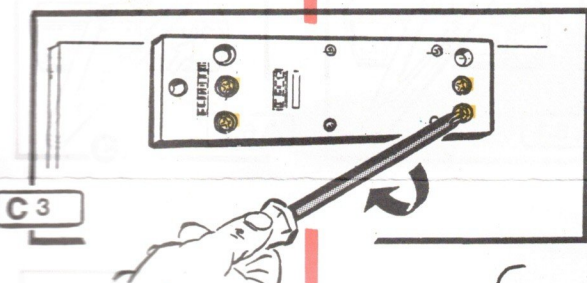
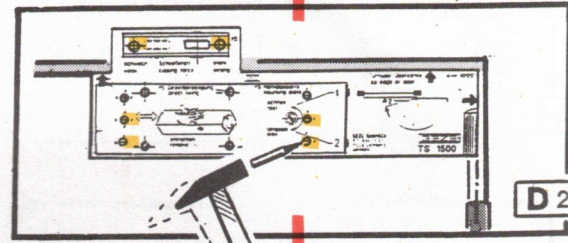
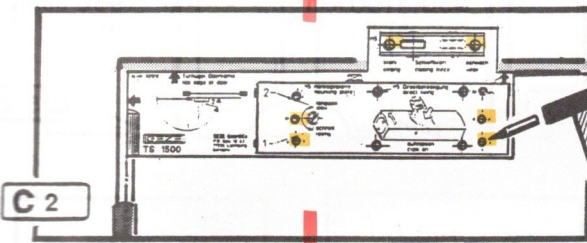
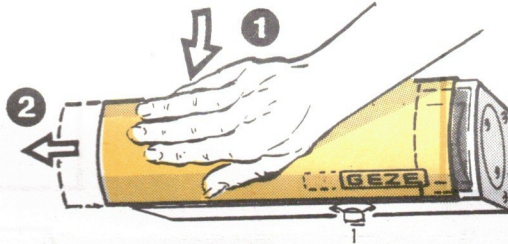
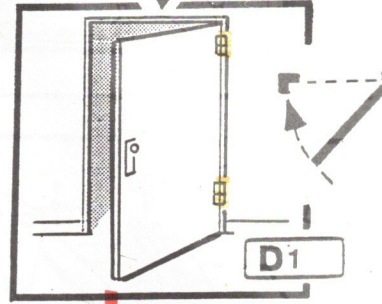

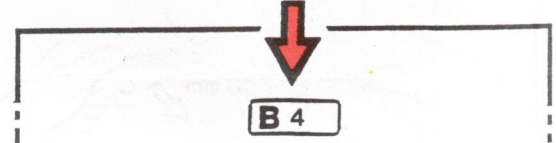
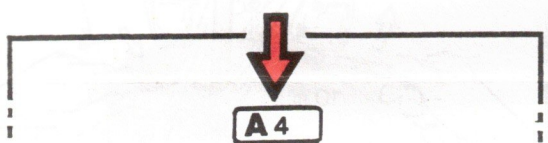
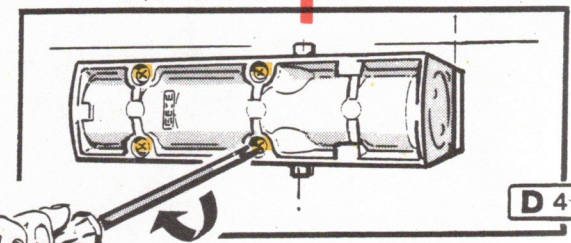
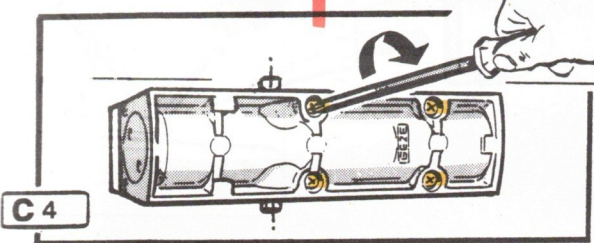
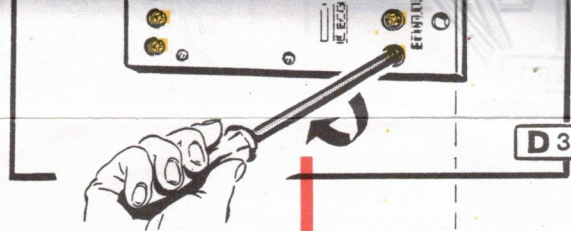
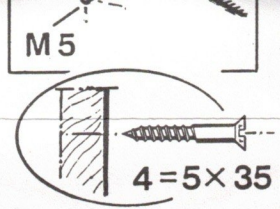
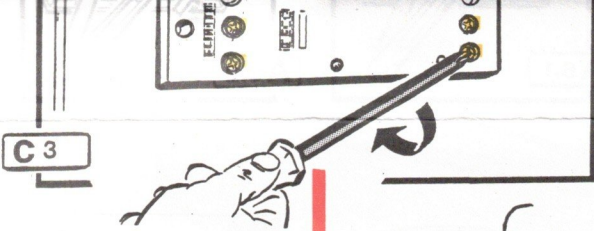

GEZE
GEZE TS 1500
 mit Rastfeststellarm

